

## RAVENA

Air Conditioner Cooling & Heating  
Climatizzatore Caldo e Freddo

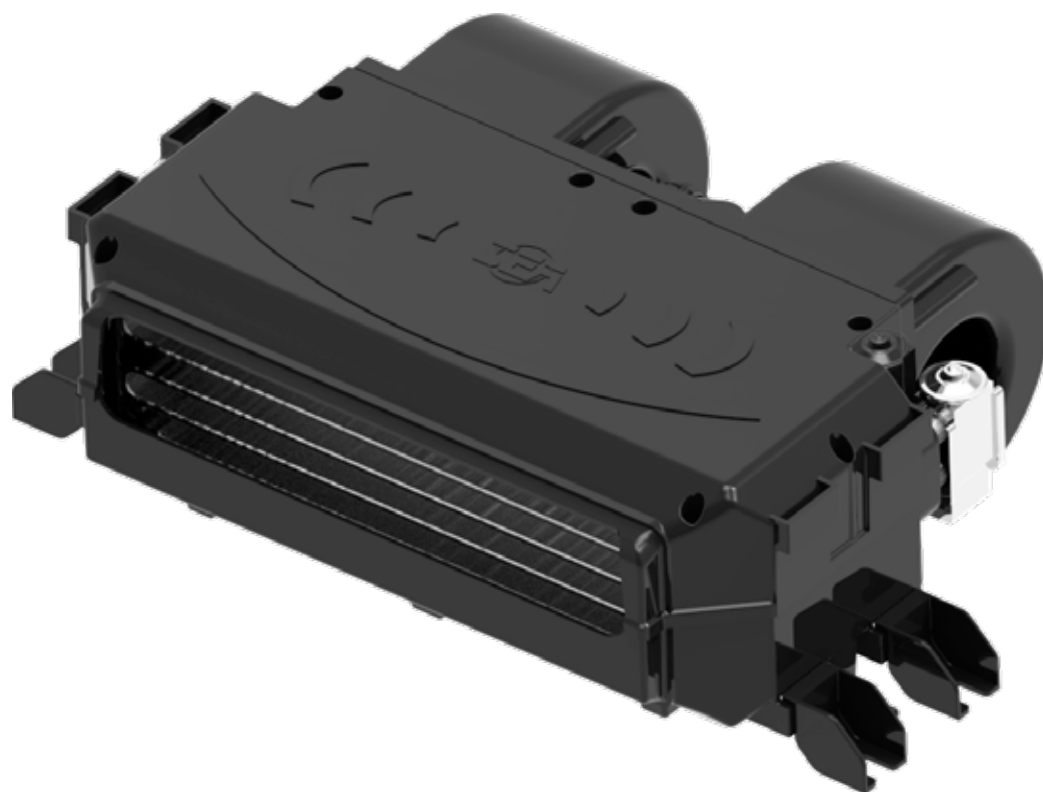

Air diffuser panel  
Pannelli per distribuzione aria

Possibility of using several diameter couplings  
for various diameter of duct.

Diameter 40-45-50-55-60 mm.

Related accessories: Section M - pag. 154

Possibilità di utilizzare giunti diversi  
a seconda del diametro del condotto.

Diametro 40-45-50-55-60 mm.

Accessori collegati: Sezione M - pag. 154

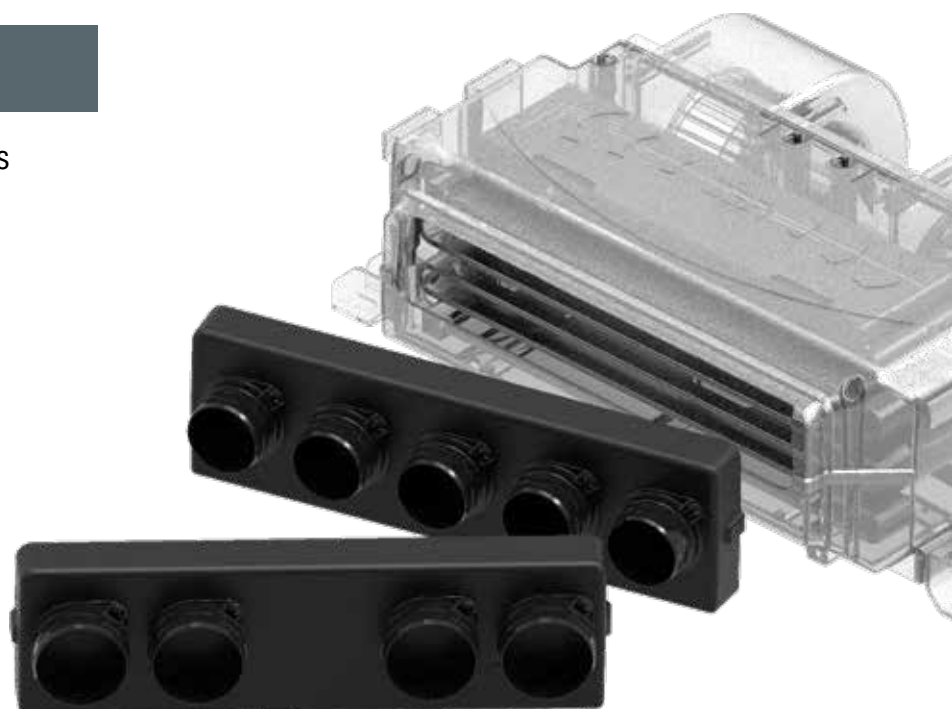

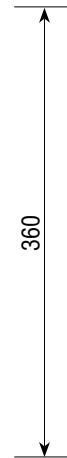
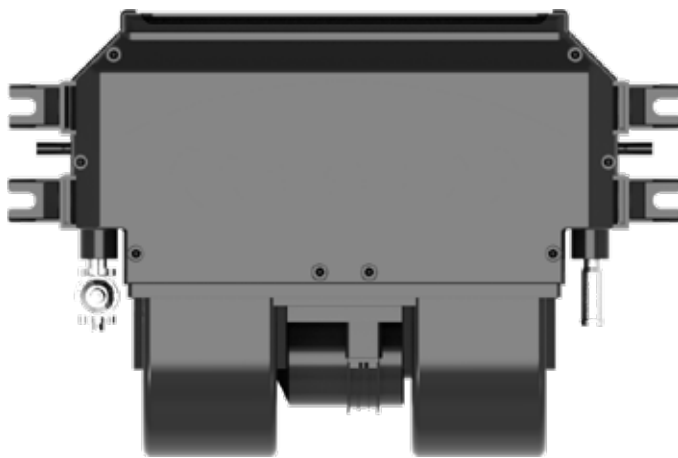
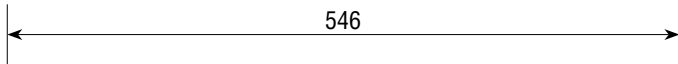
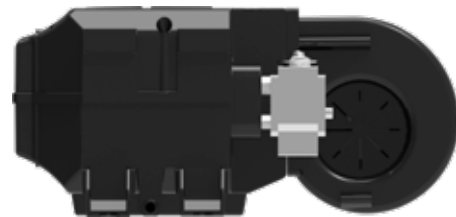
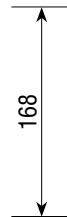

Flange expansion valve

Valvola espansione flangiata



Heater fittings 16 mm

Raccordi riscaldamento 16 mm

**RAVENA** Air Conditioner Cooling & Heating / Climatizzatore Caldo e Freddo

**HVAC** ☀️ Cooling & Heating / Freddo e Caldo

	Part. Codice	Voltage Voltaggio	Ampere Amperaggio	Cooling Freddo	Heater Caldo	Air m <sup>3</sup> /h Aria m <sup>3</sup> /h	Weight Peso	Case Rivestimento
☀️	A0CF00074ES	12 V	21 A	8.7 kW	7 kW	800	5.8 kg	Plastic injection
	A0CF00075ES	24 V	12 A	8.7 kW	7 kW	800	5.8 kg	Plastic injection
❄️	A0FF00074ES	12 V	21 A	8.7 kW	-	800	5.8 kg	Plastic injection
	A0FF00075ES	24 V	12 A	8.7 kW	-	800	5.8 kg	Plastic injection